

XCell™ ATF 2 Single-use Device

START-UP GUIDE



The information contained in this document is subject to change without notice.

Repligen Corporation makes no warranty of any kind with regard to this material, including, but not limited to, the implied warranties of merchantability and fitness for a particular purpose.

Repligen Corporation shall not be liable for errors contained herein or for incidental or consequential damages in connection with the furnishing, performance, or use of this material.

No part of this document may be photocopied, reproduced, or translated to another language without the prior written consent of Repligen Corporation.

For further information, please contact Repligen Corporation at www.repligen.com.

©2019 Repligen Corporation. All rights reserved. The trademarks mentioned herein are the property of Repligen Corporation and/or its affiliate(s) or their respective owners.

Customer Support

customerserviceUS@repligen.com

+1-781-250-0111 (option 1)

Repligen Corporation

41 Seyon Street Building #1, Suite 100

Waltham, MA 02453

www.repligen.com

Contents

1.	About this Start-up Guide	4
2.	Intended Use	4
3.	General Precautions	4
4.	Background	5
5.	Product Description and Accessories	5
5.1	Single-use Device	5
5.2	Stainless Steel Stand	6
5.3	Connection Kit	7
6.	Prerequisites	7
7.	XCell™ ATF 2 Single-use Device Connection Methods	11
7.1	Glass Bioreactor	11
7.2	Single-use Bioreactor	12
8.	Hollow Fiber Filter Wetting	13
8.1	Background	13
8.2	Wetting Procedure	13
9.	Operational Setup	17
10.	Post-use Instructions	17
11.	Frequently Asked Questions	18
12.	Index	19

List of Tables

Table 6.1	Part Numbers for XCell™ ATF 2 Single-Use System.....	9
Table 6.2	Materials of Construction for Non-Product Contact Parts.....	9
Table 6.3	Materials of Construction for Non-Product Contact Parts.....	10

List of Figures

Figure 5.1	XCell™ ATF 2 Single-use Device Flow Path and Stainless Stand.....	6
Figure 5.2	XCell™ ATF 2 Single-use Device Components	7
Figure 6.1	Connection Kit (Tubing Sets)	8
Figure 7.1	Setup of an XCell™ ATF 2 Single-use Device with a Glass Bioreactor	11
Figure 7.2	Setup of an XCell™ ATF 2 Single-use Device with a Single-use Bioreactor	12
Figure 8.1	Required Initial (Set-Up) Configuration for Wetting of the Device.....	14
Figure 8.2	Required Working Configuration for Online Wetting of the Device	15
Figure 8.3	Configuration for Disconnecting the Collection Bag from the Device	16
Figure 9.1	Final Operational XCell™ ATF 2 Single-use Device with a Bioreactor	17

Abbreviations

A2B	XCell™ ATF Device to Bioreactor Connection
A2C	XCell™ ATF Device to Controller Connection
ABS	Acrylonitrile Butadiene Styrene
ATF	Alternating Tangential Flow
DAC	Disposable Aseptic Connector
LMH	Liter meter sq. per hour
LPM	Liter per Minute
PES	Polyethersulfone
PMMA	Poly (methyl methacrylate)
PS	Polysulfone
PVDF	Polyvinylidene Fluoride
SS	Stainless Steel
SU	Single-use
SUB	Single-use Bioreactor
TPE	Thermo Plastic Elastomer
WFI	Water for Injection

1. About this Start-up Guide

This Start-up Guide is for individuals who are planning to use the Repligen XCell™ ATF 2 Single-use Device for cell culture. Although this device is very similar to the XCell™ ATF 2 Stainless Steel Device, this guide provides advice on making the appropriate connections, preparing the device for use, and initiating the cell culture process, all while maintaining sterility throughout the fluid path.

After reading this document, you will be familiar with all system components and also be able to complete the appropriate connections and configure the system to support the intended process. This guide is not intended to provide guidance on the optimization of the XCell™ ATF 2 Single-use Device operation or to provide guidance on controlling the cell culture process.

2. Intended Use

The XCell™ ATF 2 Single-use Device is intended to be used as a cell retention device to support a high cell density and high viability cell culture operation. The device is designed to enable linear scaling from XCell™ ATF 2 to XCell™ ATF 10 to support multiple scales of cell culture development. Although it is possible that the use of this device represents an initial step into this type of processing, it is assumed that similar processing with the XCell™ ATF 2 stainless steel system has been performed. Therefore, there is a presumption that the individuals following this guide are already skilled in the areas of aseptic technique, process scale fluid handling, interfacing the XCell™ ATF device with the bioreactor and the use of Repligen's XCell™ ATF C24 controller. Additional information on the use of XCell™ ATF systems can be found in the XCell™ ATF System with C24 Controller User Guide.

3. General Precautions

The sterile connection between the XCell™ ATF 2 Single-use Device and the bioreactor is made by utilizing GE ReadyMate™ Disposable Aseptic Connectors (DACs). For wetting and installation, multiple, varying flow path configurations need to be established by clamping the tubes along the flow path.

It is important to use sterile technique when making sterile connections. Once the ReadyMate™ connections have been made, the supplied nylon tri-clamp should be installed to secure the aseptic connector assembly. Once the ReadyMate™ connector assembly is secured, there should be no concern for either liquid leakage or a possible introduction of contamination during the process. It is important to ensure the tubing pinch clamps are correctly positioned to establish the required and correct flow path. Since the pinch clamps can create significant force when crimped, causing the tubing to remain closed when the clamp is released, it is best to inspect the tubing carefully to ensure it is open, and if necessary, to massage or roll the tubing carefully to open it and reestablish flow.

The XCell™ ATF2 Single-use device is supplied pre-sterilized and only requires wetting with sterile cell culture media or WFI prior to use. There is no need to sanitize a device prior to use. The devices are designed to be single-use and are therefore not designed to be cleaned, sanitized and stored for repeat use. The device should not be exposed to high pH solutions, such as sodium hydroxide for extended time. Repligen advises not to expose the device to even dilute caustic solutions prior to

use or for storage. If caustic is used for post use decontamination, the concentration should be limited to 0.1 N and the contact duration limited to one hour.

Note: Refer to the XCell™ ATF C24 User Guide for controller related precautions.

4. Background

The XCell™ ATF 2 Single-use Device is a highly efficient cell retention device that features gentle diaphragm pumping action with low shear to avoid shear stress on the cells. This system is utilized in numerous cell culture applications including continuous bioprocessing (perfusion), N-1 perfusion for seed train optimization, high density cell banking and high yield harvest or clarification of fed-batch cultures.

The XCell™ ATF 2 System is also available in the original stainless steel format. Using the gamma-irradiated/pre-sterilized XCell™ ATF Single-use Device eliminates the need for autoclave procedures, enables faster implementation time, and reduces downtime between cell culture runs and reduces validation time and expense.

The XCell™ ATF 2 Single-use Device is supplied dry. It is recommended to pre-wet the device before use to ensure optimal hollow fiber filter performance. This document describes the installation procedure for the XCell™ ATF 2 Single-use Device and tubing sets.

5. Product Description and Accessories

The XCell™ ATF 2 Single-use Device is supplied as a gamma irradiated/pre-sterilized device. The device should be placed in the stainless steel support stand, provided as an accessory, prior to use to ensure operational stability.

5.1 Single-use Device

The XCell™ ATF 2 Single-use Device components consist of a diaphragm pump, GE ReadyMate™ DAC, and a hollow fiber filter cartridge fitted to the upper hemisphere of the diaphragm pump. The device contains five ports: top retentate port, flush/drain port, top permeate port, bottom permeate port and A2C (XCell™ ATF to Controller) port. All ports, except the A2C and top retentate ports, are supplied dead-ended with 1/8" I.D. PureWeld tubing, which is utilized to connect/replace harvest/media bags via tube welding. The A2C port at the lowest point on the pump base is connected to XCell™ C24 controller allowing pressurized air and vacuum to be delivered actuating the diaphragm according to the parameters established by the controller. The top retentate port is supplied dead-ended with GE ReadyMate™ DAC to make a sterile connection between the XCell™ ATF 2 Single-use Device and a bioreactor using A2B tubing set. Apart from A2C, all other four ports are liquid carrying lines which enable hollow fiber filter cartridge preparation and operation. Two ports are connected to the feed side of the cartridge and the other two ports are connected to the permeate cavity (see Figure 5.1). Typically, the top permeate port is used for harvesting purposes and the lower permeate port remains closed off throughout the process but could be aseptically connected to a pressure transducer to monitor the permeate pressure during the process.

The hollow fiber cartridge used in the XCell™ ATF 2 Single-use Device is similar to the cartridge supplied with XCell™ ATF 2 stainless steel device. The spherical chamber at the base encompasses

the silicone diaphragm which moves up and down as a function of the pressurized air and vacuum flow on the bottom half of the sphere. The clear housing enables the viewing of the diaphragm movement. Figure 5.2 illustrates the components and materials of construction of the XCell™ ATF 2 Single-use Device.

5.2 Stainless Steel Stand

To ensure stability during set-up and use, it is recommended that the device be placed in the stainless steel, reusable stand (see Figure 5.1). The stand features a ring to hold the bottom of the device securely and a snap ring to hold the hollow fiber filter housing near the top of the device. The device snaps into the stand with a single click. After use, the device can be easily removed from the stand. The stand is provided with a notch to orient and secure the A2C line. This feature also helps orient the entire device for efficient connectivity and easy access to all the ports.

Note: The stainless steel stand and A2B tubing setup need to be ordered separately from the XCell™ ATF 2 Single-use Device.

Figure 5.1 XCell™ ATF 2 Single-use Device Flow Path and Stainless Stand

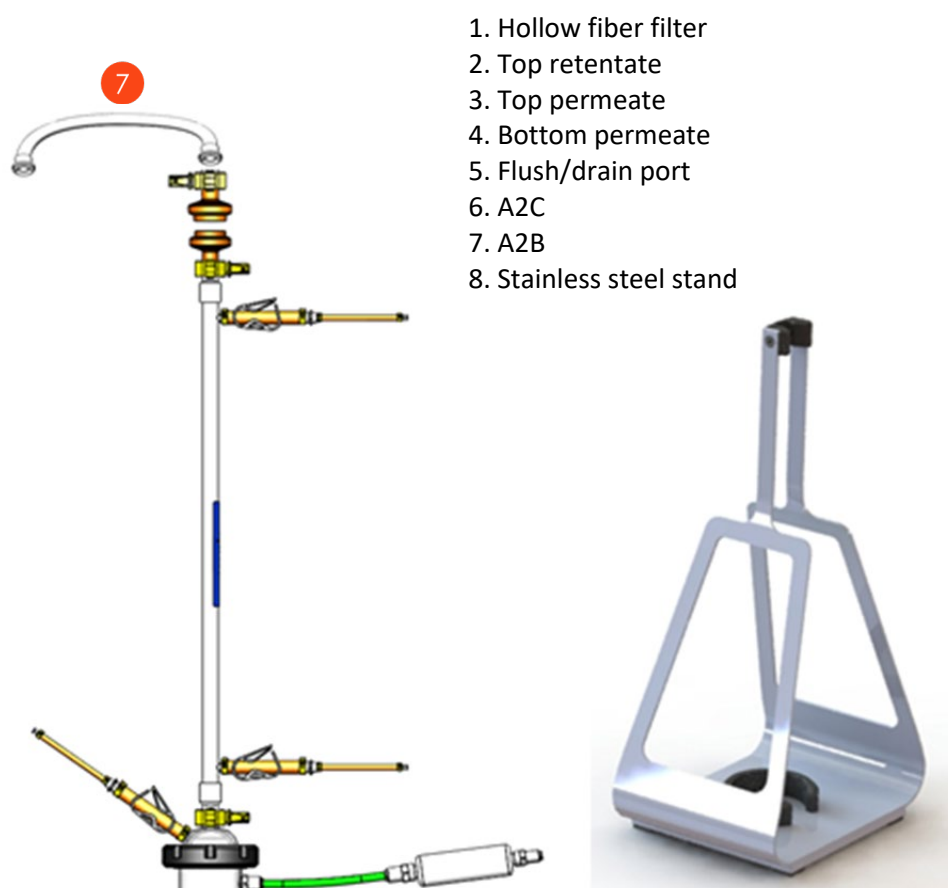
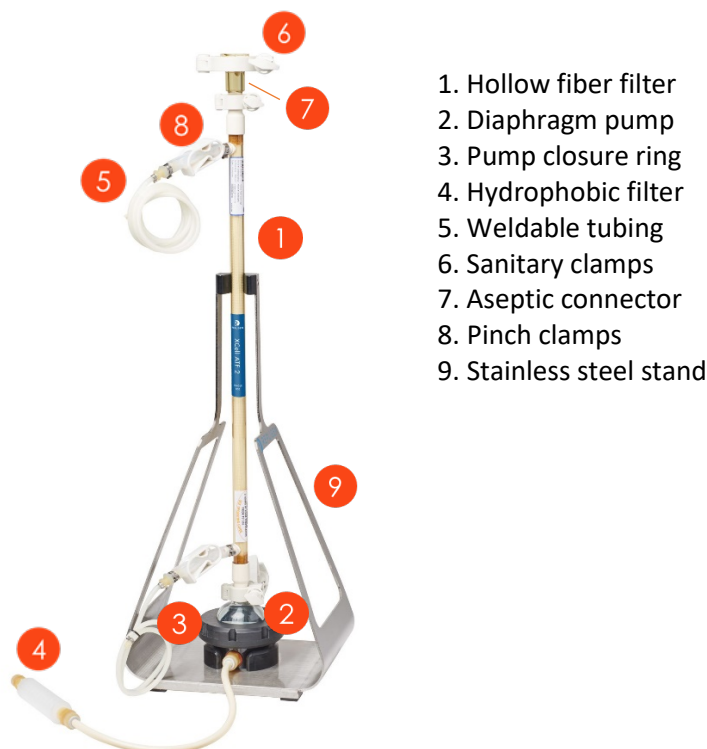

Figure 5.2 XCell™ ATF 2 Single-use Device Components



1. Hollow fiber filter
2. Diaphragm pump
3. Pump closure ring
4. Hydrophobic filter
5. Weldable tubing
6. Sanitary clamps
7. Aseptic connector
8. Pinch clamps
9. Stainless steel stand

5.3 Connection Kit

Excluding the top retentate port, all connection tubing elements are built-in with XCell™ ATF 2 Single-use Device and are designed to ensure proper XCell™ ATF 2 Single-use Device functioning. Each tubing element is made of silicone and has a PureWeld ending, which is utilized to connect/replace harvest bags during wetting procedure and perfusion processes. In addition, the tubing elements are also equipped with pinch clamps that can be used to isolate different fluid paths during the device set-up. Connection methods for XCell™ ATF 2 single-use device and bioreactor using the A2B tubing are described in Section 7.

6. Prerequisites

The following equipment (not supplied with the device) are also required to operate the XCell™ ATF 2 Single-use Device:

- a. For XCell™ ATF 2 Single-use Device
 - i. An operational, calibrated XCell™ ATF C24 controller, connected to the required air pressure and vacuum pressure sources.
 - ii. A GE ReadyMate™ DAC with mini TC fitting for making connection between XCell™ ATF 2 Single-use Device and a bioreactor.
- b. For Permeate (Harvest) Flow
 - i. A variable speed peristaltic pump capable of supporting flow rates in the range of 1-50 ml/min depending on the bioreactor working volume and perfusion rate.
 - ii. A sterile tube welder capable to create an aseptic connection between two tubing elements size 16 (I.D. 1/8" and O.D. 1/4").
 - iii. A minimum length of 1/8" I.D. weldable tubing on harvest bag. It is recommended that the permeate line be sterilized via gamma irradiation or autoclaving prior to use.
- c. For Wetting process

- i. A sterile 3L container or bag that is fitted with an appropriate length of 1/8" I.D. weldable tubing.
- ii. A variable speed peristaltic pump with a flow capacity of 100-200 mL/min, and able to accommodate the tubing IDs configured on the 3L container.

Figure 6.1 Connection Kit (Tubing Sets)

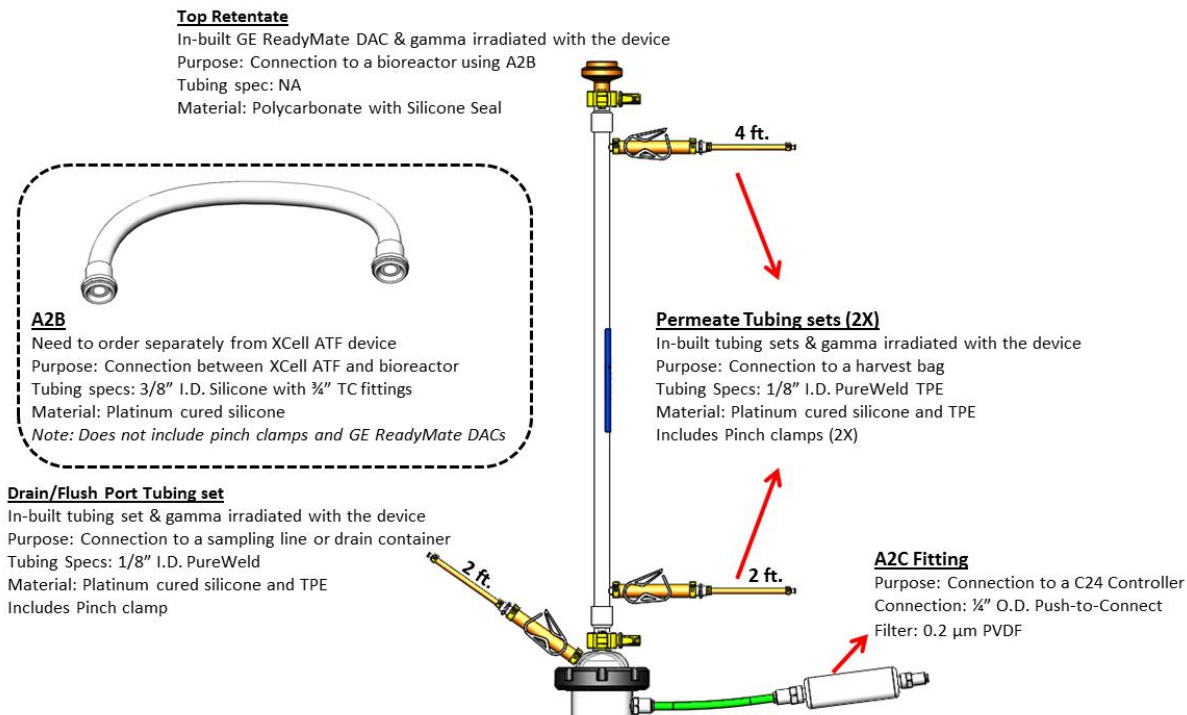

Table 6.1 Part Numbers for XCell™ ATF 2 Single-Use System

Repligen PN	Description
suATF 2-G02PS	XCell™ ATF 2 Single-use Device, 0.2µm PS
suATF 2-S02PES	XCell™ ATF 2 Single-use Device, 0.2µm PES
SUATF 2-STD	XCell™ ATF 2 Single-use Stand.
TU:S-3/4X14	A2B (For XCell™ ATF 2)
TC:DIP-10/250	DIP tube (Length: 250 mm)
TC:DIP-10/450	DIP tube (Length: 450mm)
HP:APP-M19	M19 (12mm) headplate compression fitting for Applikon vessel
HP:APP-M26	M26 (19mm) headplate compression fitting for Applikon vessel
HP:BBI-M26	M26 (19mm) headplate compression fitting for Sartorius/BBI vessel
HP:PG13.5	M19 (12mm) headplate compression fitting for any PG13.5 entry standard for most glass reactors
HP:PG13.5	M19 (12mm) headplate compression fitting for any PG13.5 entry standard for Millipore Cellready

Table 6.2 Materials of Construction for Non-Product Contact Parts

Product Contact Part	Materials of Construction
Hollow fiber filter housing and pump	Polycarbonate
Adhesive	Poly(methyl methacrylate) (PMMA)
Tubing	Platinum Cured Silicone, PureWeld XL TPE, PVDF Reducer, and Nylon Plug
GE ReadyMate™ DAC	Polycarbonate with Silicone Seal
Hollow Fiber Cartridge	PES Membrane - Polyethersulfone, Polysulfone, Polyurethane, and Polypropylene PS Membrane - Polysulfone, Polyethylene, Epoxy, and Polypropylene-
Gaskets and Diaphragm	Silicone
Hollow fiber filter housing and pump	Polycarbonate

Table 6.3 Materials of Construction for Non-Product Contact Parts

Part	Material
Sanitary Clamps	Glass-Filled Nylon
Pinch Clamps	Polyester
Tie Wraps	Nylon
Tubing Clamps	Stainless Steel
Pump Closure Ring	Acrylonitrile Butadiene Styrene
Stand	ABS, SS

7. XCell™ ATF 2 Single-use Device Connection Methods

The following schematics illustrate the connection methods of XCell™ ATF 2 Single-use Device to glass bioreactors and single-use bioreactors.

7.1 Glass Bioreactor

Figure 7.1 Setup of an XCell™ ATF 2 Single-use Device with a Glass Bioreactor

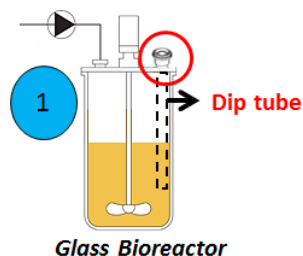

- Insert the “dip tube” in to the glass bioreactor using head plate fittings
- See table 1. for suitable head plate fittings for your bioreactor

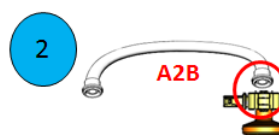

- Connect a GE ReadyMate DAC to one end of the “A2B” tubing using a sanitary connection

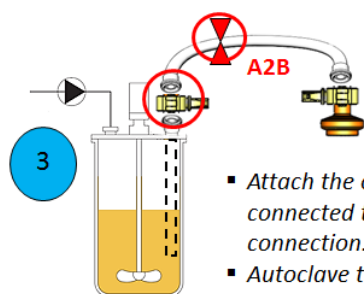

- Attach the other end of the “A2B” to the dip tube connected to the glass bioreactor using sanitary connection.
- Autoclave the entire set up including the bioreactor
- After sterilization, close the A2B line using a tube clamp

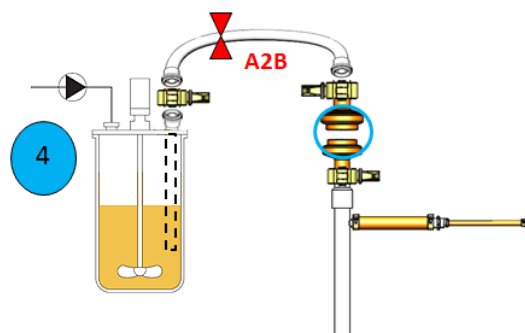

XCell ATF 2 Single-use Device

- Attach the glass bioreactor to XCell ATF 2 Single-use Device using GE ReadyMate DACs.

7.2 Single-use Bioreactor

Figure 7.2 Setup of an XCell™ ATF 2 Single-use Device with a Single-use Bioreactor

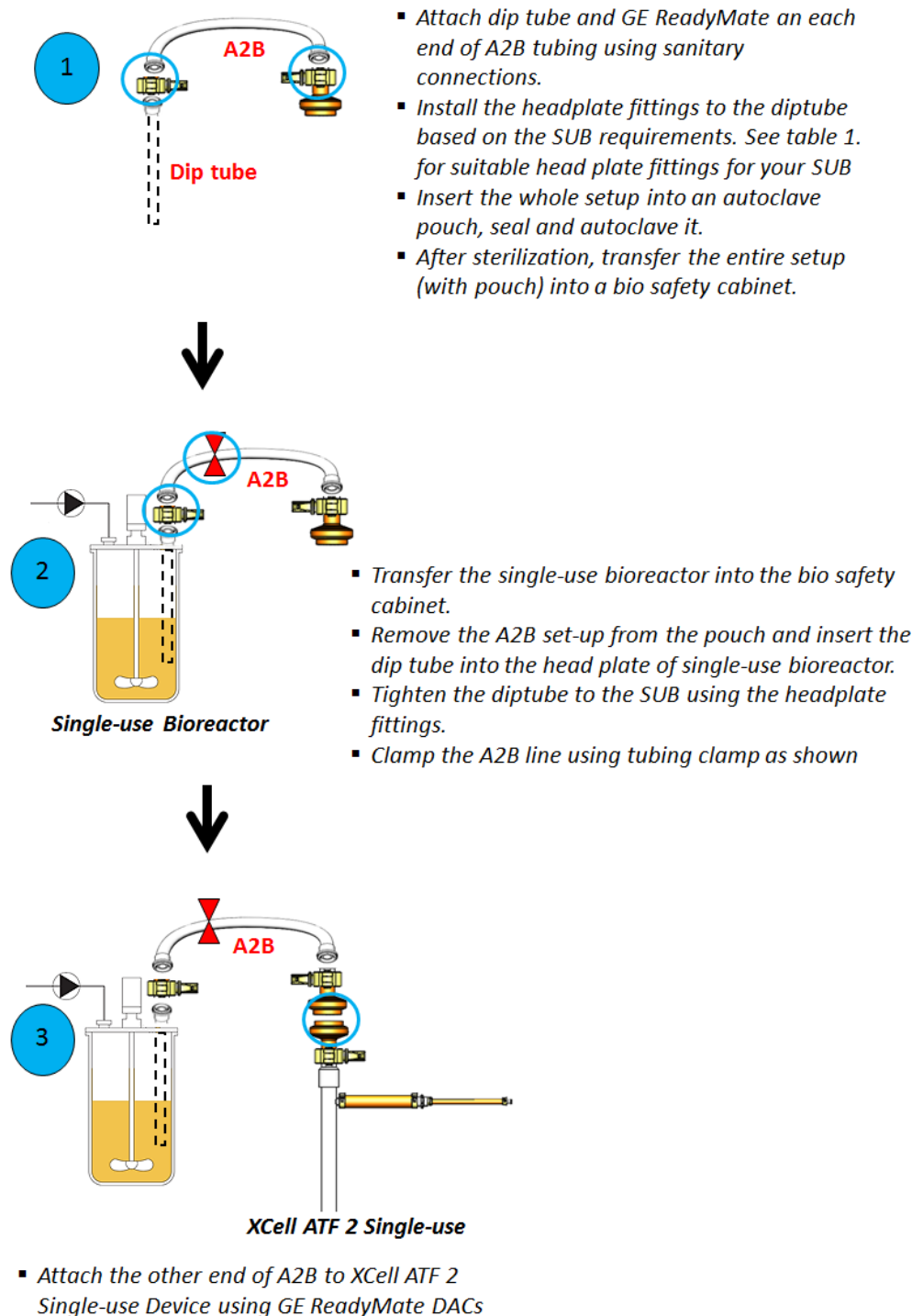

8. Hollow Fiber Filter Wetting

8.1 Background

The XCell™ ATF 2 Single-use Device is supplied in a dry condition and has not been pre-wetted or flushed. Wetting of the hollow fiber filter in the device is recommended to ensure robust performance. A minimum of 2.5L of WFI water or sterile cell culture media is required to properly wet the hollow fiber filter. The sterile wetting solution should be filled into the bioreactor connected to the XCell™ ATF 2 Single-use Device. An empty sterile 3L container or bag, configured with size 16 (1/8" I.D.) weldable tubing is required for collecting the wetting solution from the hollow fiber filter permeate side during the wetting procedure.

8.2 Wetting Procedure

The XCell™ ATF 2 Single-use Device wetting procedure is executed with the device connected to a bioreactor that contains sterile cell culture media (pre-inoculation). This method utilizes the XCell™ ATF C24 Controller to generate the pump action to wet the hollow fiber filter.

- a. Prepare the bioreactor as required for the cell culture process. The bioreactor must contain minimum of 2.5L sterile cell culture media and be cell free (pre-inoculation) for use in wetting. The device wetting should be executed prior to the bioreactor being inoculated.
- b. Set up the XCell™ ATF 2 Single-use Device by setting the device into the stand (the stand is not shown in Figure 6.1 for better visualization of the tubing pieces).
- c. Prior to connecting the device to the bioreactor, ensure that pinch clamps on all tubing sets including A2B are clamped as shown in Figure 8.1.
- d. Connect the device to the bioreactor by linking the GE Readymate™ connectors on the A2B tubing set and the XCell™ ATF 2 Single-use Device (Connection methods are described in section 7)
 - i. For an overview of the required sterile connections, please refer to the GE Readymate™ connector installation video- <https://www.youtube.com/watch?v=A1jl8IPaIOI>.
 - ii. Remember to install a tri-clamp on a linked GE Readymate™ connector to ensure proper connection and integrity to the required operating pressures.
- e. Prepare an empty 3L sterile container or bottle fitted with an appropriate length of 1/8" I.D. weldable tubing.
- f. Using the sterile welder, connect the 3L sterile container to the top permeate of XCell™ ATF 2 Single-use Device tubing segment as shown in Figure 8.2.

Figure 8.1 Required Initial (Set-Up) Configuration for Wetting of the Device

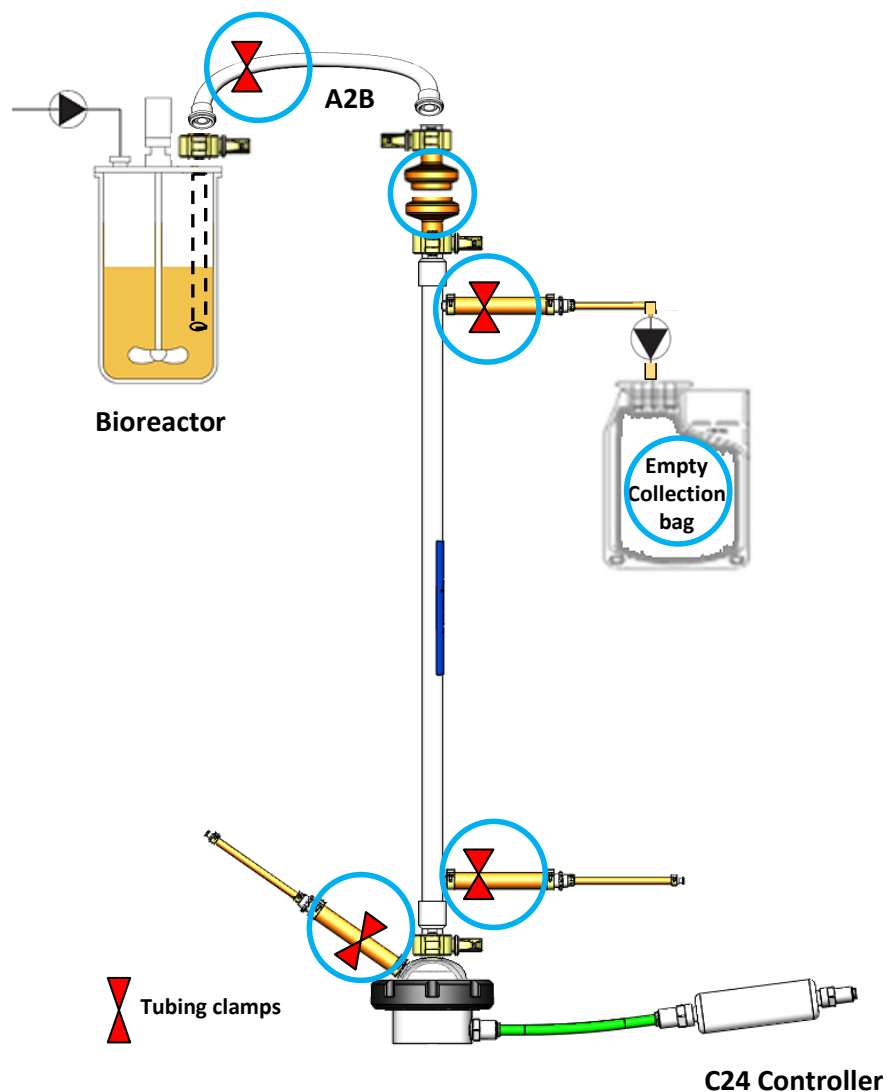

- g. Remove the clamp from the A2B tubing segment such that the line between the bioreactor and the device is open.
- h. Now connect the ATF device to C24 Controller via the A2C connection. Refer to the XCell™ ATF C24 User Guide for additional instructions on the operation of the XCell™ ATF.
- i. Start the XCell™ ATF pump from the C24 controller at a flow rate of 0.9 LPM (P and E) and let it run for few minutes until all air bubbles disappear.
- j. After equilibration, remove the pinch clamp on the top permeate port and immediately start the top permeate pump at a flow rate 160mL/min.
- k. Collect at least 2.5L of wetting solution in the top permeate collection container, see Figure 8.2.

Note: It is recommended to perform this process for more than 15 minutes to properly wet the hollow fiber filter.

Figure 8.2 Required Working Configuration for Online Wetting of the Device

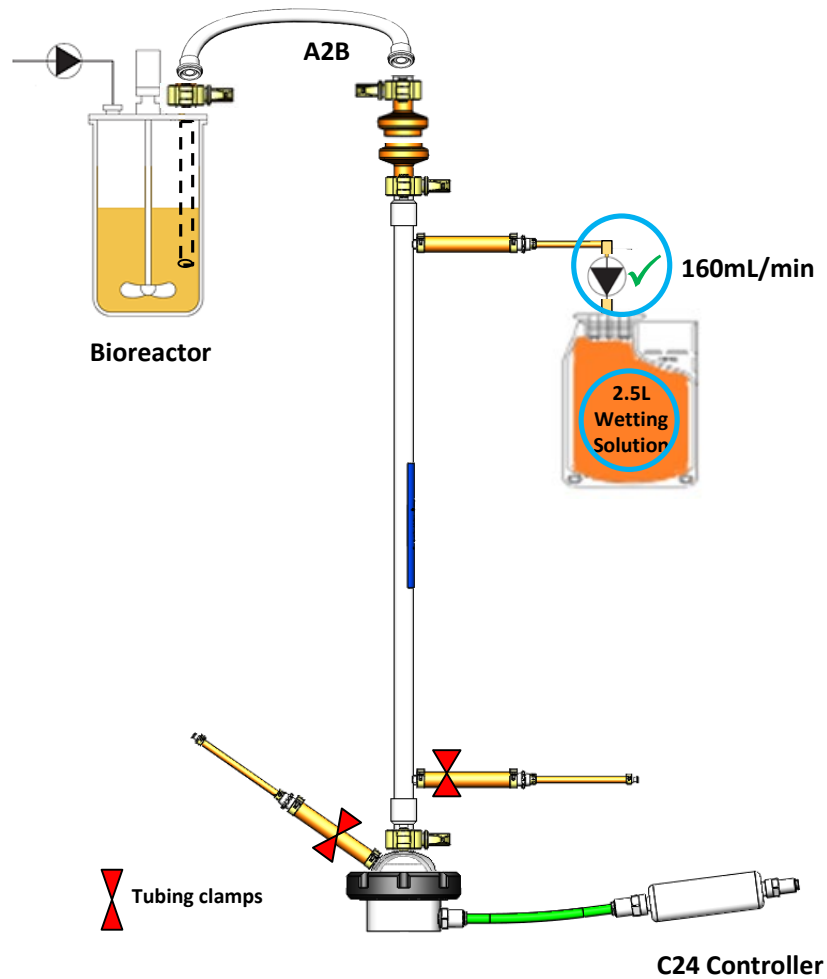

- I. After completion of the wetting process, stop the permeate pump and then the XCell™ ATF pump. Clamp the A2B tubing line and replace the collection container with a harvest bag by using a sterile welder as shown in Figure 8.3.

Note: The media from the wetting bags can be used to determine the sterility of the XCell™ ATF Single-use Device.

- m. The remaining solution inside the device can be left as-is, until the bioreactor is ready for the perfusion process.

Figure 8.3 Configuration for Disconnecting the Collection Bag from the Device

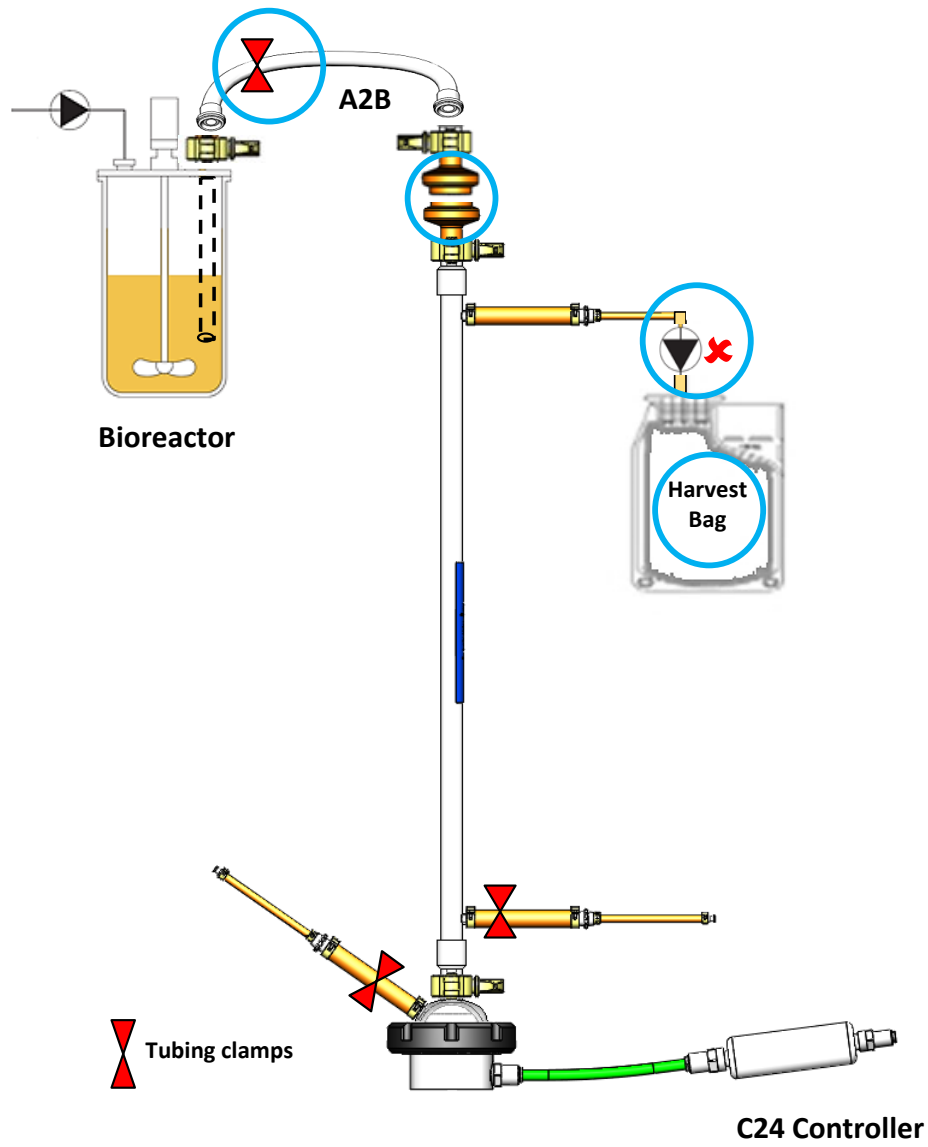

9. Operational Setup

Figure 9.1 illustrates the final, operational setups of the XCell™ ATF 2 Single-use Device with stainless steel or single-use bioreactors. The configuration of the tubing clamps is critical to proper operation and to maintain system sterility.

Figure 9.1 Final Operational XCell™ ATF 2 Single-use Device with a Bioreactor

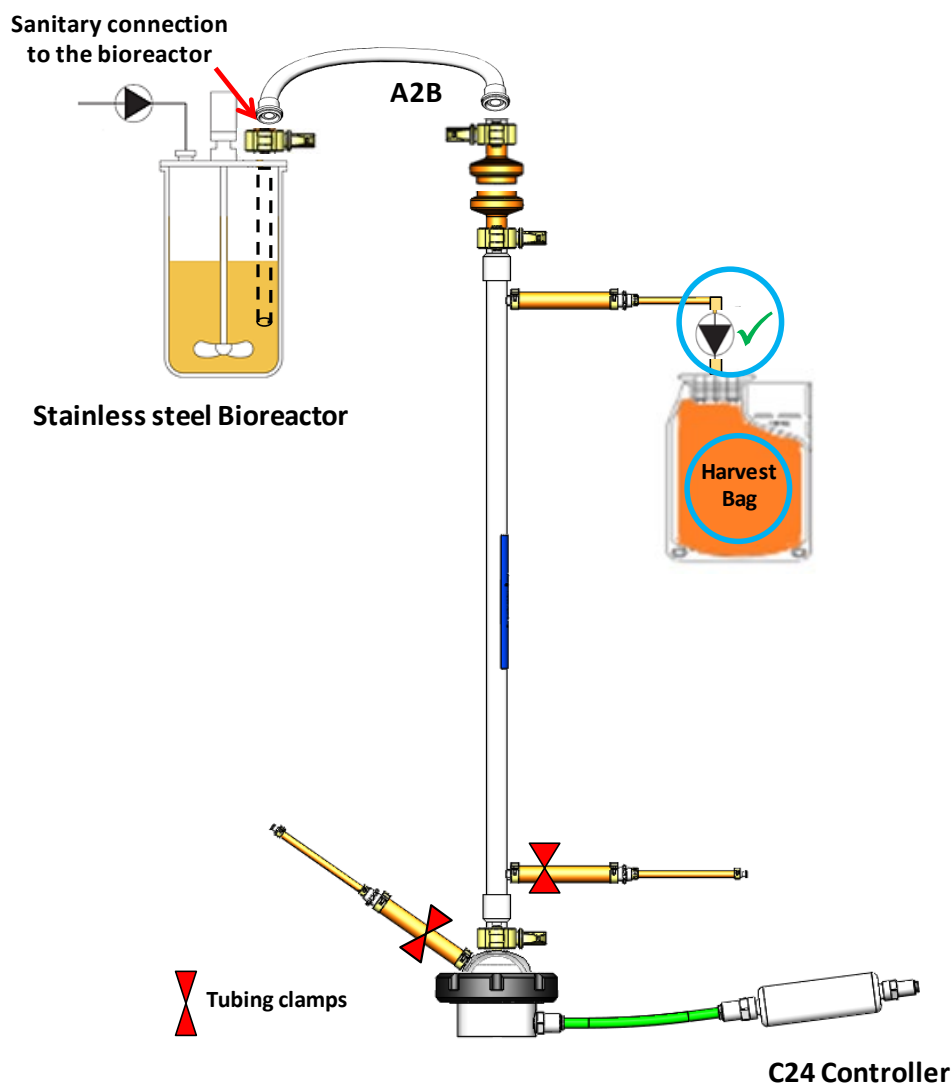

10. Post-use Instructions

After completion of a cell culture process using the XCell™ ATF 2 Single-use Device, use the following instructions to discard the device.

- Stop the permeate pump and disconnect the harvest bag in a sterile manner.
- Turn off the XCell™ C24 controller to stop the pump action and disconnect the XCell™ ATF 2 Single-use Device from the controller using A2C line.
- Clamp the A2B and top permeate tubing lines using pinch clamps.
- Prepare an empty bag or a container (1L) fitted with an appropriate length of 1/8" I.D. tubing. Connect the empty bag/container to the flush port.
- Disconnect the A2B from the bioreactor and unclamp A2B and permeate tubing lines by removing the pinch clamps.

- f. Immediately begin the draining of cell culture solution through the Flush/Drain port in to the bag/container.

Note: The device may need to be tilted in order to drain the cell culture solution from the diaphragm pump.

- g. After draining, stop the pump and disconnect the bag from the device. Now the device is ready to be discarded by following proper waste disposable codes.

11. Frequently Asked Questions

What do I do if a leak is detected during the wetting procedure?

Each individual device is pressure tested at 25psi to ensure the integrity of the entire assembly. However, if a leak is detected during wetting process, immediately stop the XCell™ ATF pump and identify the location of the leak. Please ensure that the pinch clamps are appropriately installed at proper locations. Clamping at wrong locations during wetting procedure pressurizes the device and may result in leakage. If no faults were found in setup, please contact a local Sales Manager or customer service for further support.

How do I ensure the sterility of an XCell™ ATF 2 Single-use Device?

The wetting solution collected from wetting procedure can be incubated in a shake flask at 37°C for 24 hours to assess the sterility of a device.

How long can the XCell™ ATF 2 Single-use Device be stored in a wet condition before using it for perfusion process?

After completing the wetting procedure, all the tubing segments including the A2B must be closed using pinch clamps. The device can be stored in a wet condition for one week before initiating the perfusion process.

Does the XCell™ ATF 2 Single-use Device perform similarly to XCell™ ATF 2 Stainless Steel Device?

Yes, the hollow fiber filter used in the XCell™ ATF 2 Single-use Device is the same hollow fiber filter used in the XCell™ ATF 2 stainless steel systems. In addition, the diaphragm pump configuration (size, volume and silicone diaphragm) is the same for the XCell™ ATF 2 Single-use and stainless steel devices. Only the materials of construction differ. Lastly, both devices are operated using the same XCell™ ATF C24 controller. For comparison purposes, perfusion cultures were also performed on single-use and stainless steel devices. Results suggest that there is no difference in cell growth, viability, achievable cell density and protein production profiles between the two devices.

12. Index

Connection Kit.....	1, 2, 7, 8	Single-use Bioreactor.....	1, 2, 3, 12
Glass Bioreactor	1, 2, 11	Sterility.....	4, 15, 17, 18
Hollow Fiber Filter.....	5, 6, 13, 14, 18	Tubing Sets.....	5, 13
Online Wetting.....	2, 15	Wetting Procedure	7, 13, 18