

KrosFlo® TFF System - Auxiliary Scale

Model ACSS-60K

User Guide

For use with:

- KrosFlo® KR2i Tangential Flow Filtration (TFF) System
- KrosFlo® KMPi Tangential Flow Filtration (TFF) System



The information contained in this document is subject to change without notice.

Repligen Corporation makes no warranty of any kind with regards to this material, including, but not limited to, the implied warranties of merchantability and fitness for a particular purpose.

Repligen Corporation shall not be liable for errors contained herein or for incidental or consequential damages in connection with the furnishing, performance, or use of this material.

No part of this document may be photocopied, reproduced, or translated to another language without the prior written consent of Repligen Corporation.

Products are not intended for diagnostic or therapeutic use or for use in vivo with humans or animals.

For further information, please contact Repligen Corporation at www.repligen.com.

©2020 Repligen Corporation. All rights reserved. The trademarks mentioned herein are the property of Repligen Corporation and/or its affiliate(s) or their respective owners.

Customer Support

customerserviceUS@repligen.com

310-885-4600

Repligen Corporation

18617 South Broadwick Street

Rancho Dominguez, California 90220

www.repligen.com

Contents

1. General precautions	7
2. KrosFlo® TFF System - Auxiliary Scale	7
2.1 System assembly	8
2.2 Operating instructions	10
2.2.1 Operational panel	10
2.2.2 Operating the auxiliary scale	10
3. Weighing	12
3.1 Good weighing practice	12
3.2 Zeroing	12
3.3 Taring	12
3.3.1 Entering tare value manually	13
3.4 Units	13
3.4.1 Start unit	13
3.4.2 Temporary unit	13
4. Calibration	13
4.1 External calibration	14
4.2 User calibration	14
4.3 Calibration report	14
5. Scale parameters	14
5.1 Filter	14
5.2 Value release	15
5.3 Ambient conditions	15
5.4 Autozero function	15
5.5 Tare entering mode	15
5.6 Tare value memory	16
5.6.1 Entering tare value to scale memory	16
5.6.2 Selecting tare value from the scale memory	16
5.7 Last digit	16
6. Communication	17
6.1 RS232 (1) port settings	17
7. Peripheral devices	17
7.1 Computer	17
7.1.1 Port	17
7.1.2 Continuous transmission	17
7.1.3 Printout interval for continuous transmission	18
7.1.4 Printer	18
7.1.5 Port	18
7.2 Additional display	18
7.2.1 Port	18
8. Printouts	18
8.1 Calibration report	18
8.2 GLP printout	19
9. Miscellaneous parameters	20
9.1 Backlight	20
9.2 'Beep' sound	20
9.3 Automatic shutdown	20
9.4 Date and time	20
9.5 Default user settings	21
10. Scale Data	21
11. Working modes – General information	21
11.1 Running working mode	22
11.2 Working mode local settings	22
11.2.1 Working mode accessibility	22

11.2.2	Save mode.....	22
11.2.3	Automatic printout interval.....	23
11.2.4	Lo threshold.....	23
12.	Working mode – Weighing.....	23
12.1	Local settings.....	23
13.	Working mode – Parts Counting.....	24
13.1	Local settings.....	24
13.1.1	Working mode selection.....	24
13.2	Setting reference sample mass by entering mass of a single part.....	24
13.3	Setting reference sample mass by determining mass of a single part.....	24
14.	Working mode - +/- control.....	25
14.1	Local settings.....	25
14.2	Declaring checkweighing thresholds.....	25
15.	Working mode – Percent Weighing.....	26
15.1	Local settings.....	26
15.1.1	Working mode selection.....	26
15.2	Reference mass determined by weighing.....	26
15.3	Reference sample mass by determining mass of a single part.....	26
16.	Working mode – Peak Hold.....	27
16.1	Local settings.....	27
16.2	Peak Hold operation.....	27
17.	Totalizing.....	27
17.1	Local settings.....	27
17.2	Totalizing operation.....	28
18.	Working mode – Animal Weighing.....	29
18.1	Local settings.....	29
18.2	Animal Weighing operation.....	29
19.	Maintenance.....	29
19.1	Cleaning ABS components.....	29
19.2	Cleaning stainless steel components.....	30
19.3	Cleaning aluminum components.....	30
20.	Mechanical design.....	31
20.1	Dimensions.....	31
20.2	Connectors arrangement.....	31
21.	Troubleshooting.....	32
22.	Error messages.....	32
23.	Index.....	33

List of tables

Table 1.	Auxiliary scale parts	7
Table 2.	Auxiliary scale keys	10
Table 3.	Auxiliary scale menu	10
Table 4.	Auxiliary scale menu navigation	11
Table 5.	Good weighing practices	12
Table 6.	Calibration report variable list.....	19
Table 7.	GLP weighing printout variable list.....	19
Table 8.	GLP date and time printout variable list.....	21
Table 9.	Scale Data	21
Table 10.	Working mode settings	22
Table 11.	Save mode options	23
Table 12.	Weighing – Local settings	23
Table 13.	Parts Counting – Local settings.....	24
Table 14.	+/- control – Local settings	25
Table 15.	Percent Weighing – Local settings.....	26
Table 16.	Peak Hold – Local settings	27
Table 17.	Totalizing – Local settings.....	28
Table 18.	Animal Weighing – Local settings.....	29
Table 19.	Troubleshooting suggestions.....	32
Table 20.	Error messages	32

List of figures

Figure 1.	KrosFlo® TFF - Auxiliary Scale components	7
Figure 2.	Auxiliary scale parts	7
Figure 3.	Packaging removal.....	8
Figure 4.	Transport lock removal.....	8
Figure 5.	Leveling the scale	8
Figure 6.	Replace weighing pan.....	9
Figure 7.	Interface cable to scale connection.....	9
Figure 8.	Interface cable to octopus cable	9
Figure 9.	Auxiliary scale keypad	10
Figure 10.	Calibration report example	19
Figure 11.	GLP printout example.....	20
Figure 12.	Totalizing printout example	28
Figure 13.	Scale dimensions	31
Figure 14.	Scale connectors.....	31
Figure 15.	RS-232 connector	31

Abbreviations

Acc	Access
CAL	Calibration
CdF	Calibration difference
Conn	Communication
CtP	Calibration type
dSh	Dashed
dAt	Date
ducE	Peripheral devices
Err	Error
Func	Function
InFo	Information
Int	Interval
Lo	Low
Othr	Other
Prnt	Printouts
rEAd	Readout
SiG	Signature
tin	Time

KrosFlo® TFF System – Auxiliary Scale

The KrosFlo® TFF System – Auxiliary Scale assembly and operation may vary based on application. The instructions below are for general use. For questions about specific application set up or customization, please contact your local Repligen representative.

Figure 1. KrosFlo® TFF - Auxiliary Scale components



1. Display and operations keypad
2. Weighing pan

1. General precautions

- Remove the contents from the packaging. If a part is missing, contact Repligen for replacement
- Prior to the first use, carefully read this User Guide. Use the device only as intended
- Scales to be decommissioned must be decommissioned in accordance with valid legal regulations

2. KrosFlo® TFF System - Auxiliary Scale

Table 1. Auxiliary scale parts

Part description	Quantity
ACSS-60K scale	1
6' Interface cable	1

Figure 2. Auxiliary scale parts

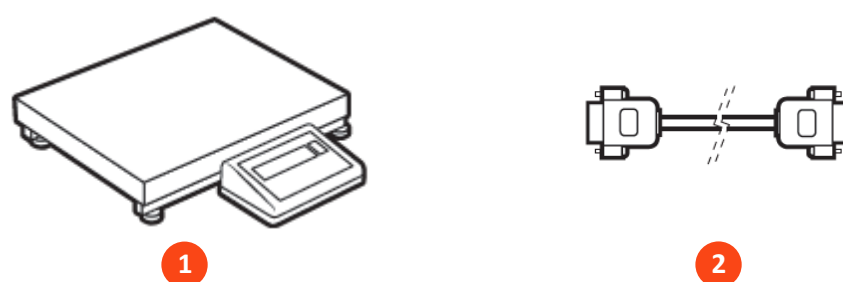

1. ACSS-60K scale
2. 6' Interface cable

1. Place the balance on a solid surface to ensure stability. Operate the balance in a room where the temperature ranges between 10 - 40° C (50 - 104° F).
2. The balance must be positioned away from heat sources, magnetic fields, vibrations, and air drafts to receive stable and repeatable results. Balance is to not to be used for explosive materials.

2.1 System assembly

1. Remove unit from packaging.

Figure 3. Packaging removal

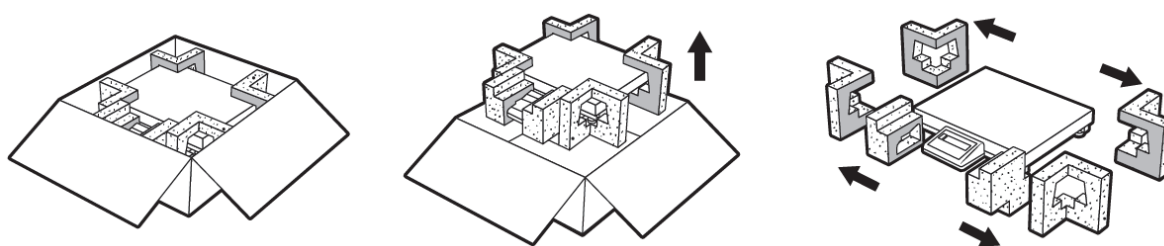

2. Remove unit transport locks. Once removed replace the weighing pan.

Figure 4. Transport lock removal

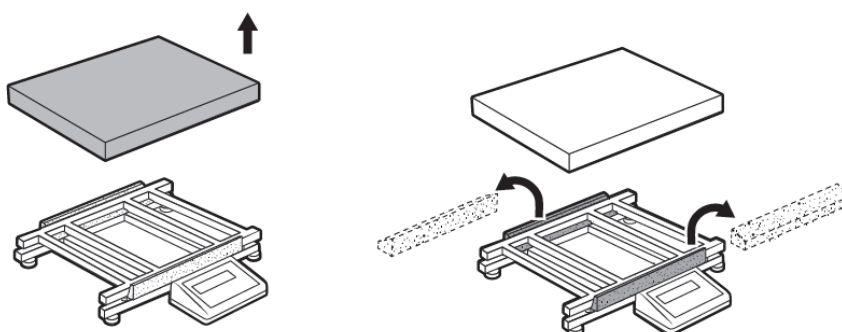

1. Level the scale by turning the feet and monitoring the leveling vial. Continue to adjust the feet until the air bubble takes the central position.

Figure 5. Leveling the scale

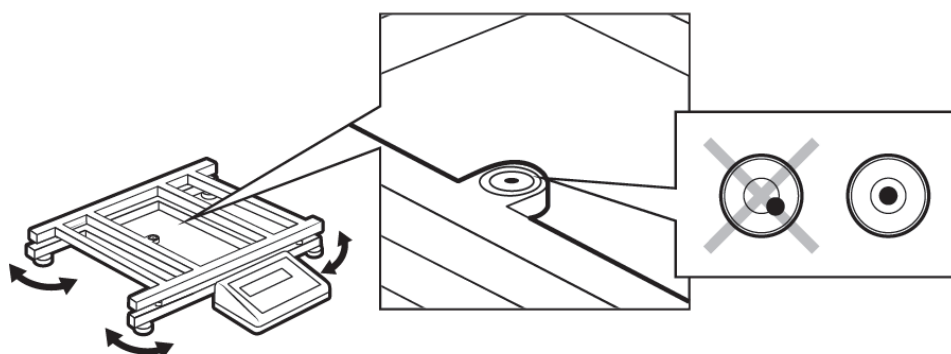

2. Replace weighing pan.

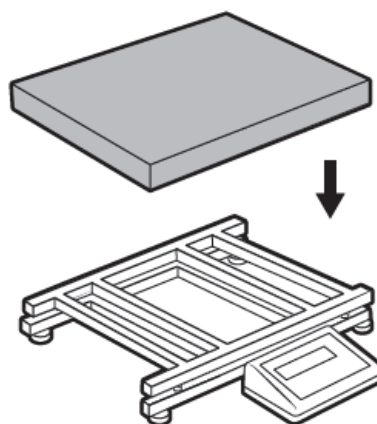
Figure 6. Replace weighing pan

3. Prior to switching the balance on, let it reach room temperature (estimated stabilization time: 1 - 8 hours).
4. Connect the adapter cable (DB9-M) to the rear of the scale. During this process there should be no load on the weighing pan.

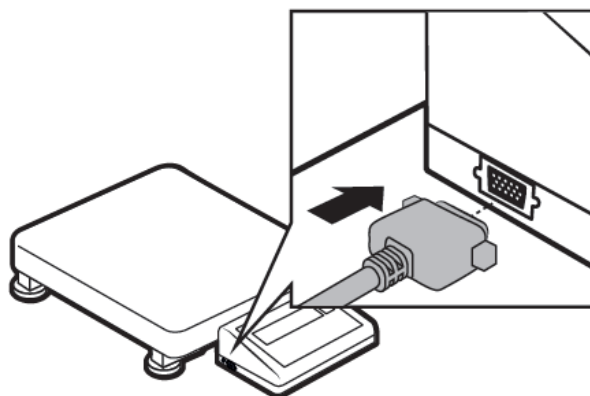
Figure 7. Interface cable to scale connection

5. Connect the adapter cable (DB9-F) to the auxiliary component octopus cable.

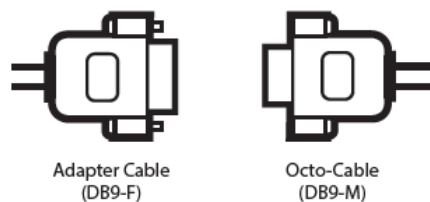
Figure 8. Interface cable to octopus cable

2.2 Operating instructions

2.2.1 Operational panel

Figure 9. Auxiliary scale keypad

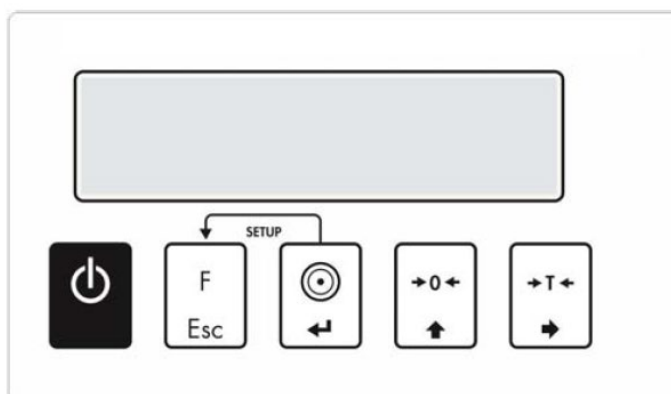







Table 2. Auxiliary scale keys

Key	Function
	Press to switch the weighing device on/off – hold the key for about 1 second
	Function key, press to change the working mode
	Press to send the weighing result to a printer or a computer
	Press to zero the scale
	Press to tare the scale











2.2.2 Operating the auxiliary scale

Table 3. Auxiliary scale menu

Function group number	Function group name	Description
P1	CAL	User calibration
P2	rEAd	Readout parameters
P2	Func	Working modes
P4	Conn	Communication
P5	ducE	Peripheral devices
P6	Prnt	Printouts
P7	Othr	Operation-related functions
P8	InFo	Scale information
P9	Unit	Units

In order to navigate the auxiliary scales menu, utilize the keypad.

Table 4. Auxiliary scale menu navigation

Key	Description
 + 	Press to enter the main menu
 + 	Press to: <ul style="list-style-type: none"> • Enter tare manually • Enter tare from tare database • Change value by 1 digit up • Scroll the menu up
 + 	Press to view date/time
	Press to: <ul style="list-style-type: none"> • Scroll the menu down • Change current parameter value
	Press to enter given submenu. Press to modify given parameter
	Press to confirm modification
	Press to: <ul style="list-style-type: none"> • Exit, function remains unmodified • Move one menu level up

3. Weighing

3.1 Good weighing practice



To assure long-term operation and correct mass measurement, follow the rules presented below:

Table 5. Good weighing practices



Recommendation	
Load the weighing pan steadily avoiding mechanical shocks	
Place weighed loads centrally on the weighing pan (eccentricity errors are specified by EN 45501 standard, point 3.6.2.)	
Do not apply concentrated force (total load in one point)	
Avoid side loading, in particular side shocks	

3.2 Zeroing



- To zero mass indication press  key, during this process the weighing pan must be empty.
- With the zeroing of the scale, the pictograms $\rightarrow 0 \leftarrow$ and  are displayed. The scale can only be zeroed when the indication is stable.
- Indication can be zeroed only within $\pm 2\%$ range of the maximum capacity. If the zeroed value is greater than $\pm 2\%$ of the maximum capacity, then the scale displays message **<Err2>**, and short sound signal is heard.





3.3 Taring

- To determine the net weight value, load the weighing pan with a package. Wait for the stable indication, , and press  key.
- The zero indication and the following pictograms are displayed: **Net** and .
- The scale has now been tared. Upon loading, net mass is displayed.

- Taring can be carried out repeatedly within the whole weighing range. Do not exceed the maximum capacity, i.e. sum of tare weight value and load weight value must be lower than the maximum capacity value.
- Upon unloading, the sum of tared masses with a minus sign is displayed. To return to zero

point press  key.



3.3.1 Entering tare value manually

- Press  and  keys combination, tare value edit box is displayed.
- Enter tare value. To do so press  to set digit value (0 - 9) and  to select digit to be edited.
- Press  key to confirm, the scale returns to the weighing mode, modified tare value with '-' sign is displayed.
- You can enter tare value at any time during the weighing operation.

3.4 Units



<P9.Unit> parameter group enables change of start unit and temporary unit. The units can be changed during weighing or during other working modes operation. 'Parts Counting' and 'Percent Weighing' modes are exceptions.

3.4.1 Start unit

- Enter <P9.Unit/9.1.UnSt> submenu.
- Press  key, available units are displayed successively one by one. Available units are: kg (kilogram), g (gram), lb (pound), N (Newton).
- Select start unit and press  key. To return to home screen press  key.
- Upon restart, the scale runs with the set start unit.

3.4.2 Temporary unit

Temporary unit runs from the moment it is set to the scale shut-down and restart.

- Enter <P9.Unit/9.2.Unin> submenu
- Press  key, available units are displayed successively one by one. Available units are: kg (kilogram), g (gram), lb (pound), N (Newton).
- Select start unit and press  key. To return to home screen press  key.

4. Calibration



In order to ensure the highest weighing accuracy, it is recommended to periodically introduce corrective factor of indications to scale memory. This factor is a known reference weight which is used to perform a calibration of the scale.

Calibration is recommended to be carried out:

1. Prior to weighing.
2. If long breaks between successive measuring series occurs.
3. If the ambient temperature has changed dynamically.
4. If the scale has been relocated.



4.1 External calibration

External calibration must be carried out using an external calibration weight of class F₂.

1. Enter **<P1.CAL / 1.1.CA-E>** submenu, the text **<UnLoAd>** will be displayed.
2. Remove any load from the weighing pan and press  key.
3. Mass of the empty weighing pan is determined; this is signaled with display of dash **<- >**.
4. Text **<LoAd>** is displayed along with required mass value, **<50.000kg>**.
5. Load the required mass value, press  key.
6. Weigh mass is determined; this is signaled with display of dash **<- >**. Once complete, text **<UnLoAd>** will be displayed.
7. Remove mass from weighing pan, scale returns to **<P1.CAL / 1.1.CA-E>** submenu.

4.2 User calibration

User calibration must be carried out using an external calibration weight of class F₂. The calibration weight value is specified by sure and must be of a mass equal or greater than 30% of maximum capacity.

1. Enter **<P1.CAL / 1.2.CA-u>** submenu, edit box for declaring weight mass is displayed (the mass value must be $\geq 30\%$ of the maximum capacity value).
2. Enter weight mass value and press  key, the text **<UnLoAd>** will be displayed.
3. Remove any load from the weighing pan and press  key.
4. Mass of the empty weighing pan is determined; this is signaled with display of dash **<- >**.
5. Text **<LoAd>** is displayed along with user inputted mass value, i.e. **<20.000kg>**.
6. Load the required mass value, press  key.
7. Weigh mass is determined; this is signaled with display of dash **<- >**. Once complete, text **<UnLoAd>** will be displayed.
8. Remove mass from weighing pan, scale returns to **<P1.CAL / 1.2.CA-u>** submenu.

4.3 Calibration report



The calibration report is automatically printed (using scale-connected printer) at the end of each calibration process. To declare report content, go to **<P6.1.CrEP>** submenu.

5. Scale parameters

Scale parameters are set to adjust the weighing device to ambient conditions (filters) or individual needs (autozero, on/off, tare values memory). These parameters can be found in **<P2.rEAd>** submenu.

5.1 Filter



1. Enter **<P2.rEAd / 2.1.Fil>** submenu.

2. Press  key, filter values are displayed successively one by one, where: **1** - Fast, **2** - Average, **3** – Slow.
3. Set respective value and press  key to confirm, next go to the home screen.



Note: The higher filter value, the longer the indication takes to stabilize.

5.2 Value release

Enter this parameter to adjust rate of stabilization of the measurement result. Depending on the selected option, weighing time is either shorter or longer.

1. Enter <P2.rEAd / 2.2.APPr> submenu.
2. Press  key, filter values are displayed successively one by one, where: **F_P** – Fast and Reliable, **PrEc** - Reliable, **FASt** – Fast.
3. Set respective value and press  key to confirm, next go to the home screen.



5.3 Ambient conditions

4. Parameter relating to ambient and environmental conditions of the workstation. Enter this parameter and set 'nStAb' value if the ambient conditions are unfavorable (air drafts, vibrations).
5. Enter <P2.rEAd / 2.3.Enut> submenu.
6. Press  key, filter values are displayed successively one by one, where: **nStAb** – unstable, **StAb** – stable.
7. Set respective value and press  key to confirm, next go to the home screen.

5.4 Autozero function

'Autozero' function has been designed to enable automatic control of zero indication. This guarantees precise weighing results.

There are, however, some cases where this function can be a negative factor in the measuring process, e.g. very slow loading of the weighing pan (load adding, e.g. pouring, filling). In such case, it is recommended to disable the function.



1. Enter <P2.rEAd / 2.4.Aut> submenu.
2. Press  key, filter values are displayed successively one by one, where: **YES** – Function enabled, **no** – Function disabled.
3. Set respective value and press  key to confirm, next go to the home screen.

5.5 Tare entering mode

The tare is entered using  and  keys combination. There are two enter modes.

1. Enter <P2.rEAd / 2.6.ttr> submenu.

2. Press  key, filter values are displayed successively one by one: **tArEH** -to enter tare value manually, **tArnn** – to enter tare value that is stored in scale memory.

3. Set respective value by using  and  keys.

4. Press  key to confirm, next go to the home screen.

5.6 Tare value memory



It is possible to store 10 tare values in scale memory.

5.6.1 Entering tare value to scale memory

1. Enter <P2.rEAd / 2.7.tArn> submenu, name of tare no. 1 from tare database is displayed

(<tArE 0>), to select a different record press  key.

2. Select respective entry and press  key, tare value edit box is displayed.

3. Enter tare value, to do this press  to select digit to be edited and  to set digit value (0 - 9).

4. Press  key to confirm, <tArE 0> is displayed.

5. Press  to return to home screen.

5.6.2 Selecting tare value from the scale memory

1. Enter <P2.rEAd / 2.7.tArn> submenu, name of tare no. 1 from tare database is displayed

(<tArE 0>), to select a different record press  key.

2. To select a tare value press  key.

3. The set tare value is displayed on the screen with a minus sign, **Net** symbol is shown in the upper-left corner of the screen.

Note: The tare value acquired from the weighing device memory is not remembered upon the weighing device restart.

5.7 Last digit

Function designed to disable display of the last weighing indication digit, this results with less accurate measurement.

1. Enter <P2.rEAd / 2.8.LdiG> submenu.



2. Press  key, filter values are displayed successively one by one, where: **ALAS** – Last digit always on, **nEur** – Last digit always off, and **uuSt** – Last digit on only when the weighing indications is stable.

- Set respective value and press  key to confirm, next go to the home screen.

6. Communication

Communication between the scale and peripheral devices is established via RS232 port. To set the ports go to **<P4.Conn>** submenu.

6.1 RS232 (1) port settings

- Enter **<P4.Conn / 4.1.rS1>** submenu.
- Submenu **<4.1.1.bAd>** sets the baud rate. Press  key, and rates are displayed successively one by one: **2400, 4800, 9600, 19200, 38400, 57600, 115200 bit/s.**
- Submenu **<4.1.1.bAd>** sets the baud rate. Press  key, and rates are displayed successively one by one: **2400, 4800, 9600, 19200, 38400, 57600, 115200 bit/s.**
- Set respective value and press  key to confirm, next go to the home screen.

7. Peripheral devices



<P5.ducE> menu contains list of devices connecting with the scale.

7.1 Computer



<5.1.PC> submenu allows to:

- Select port to which the computer is connected
- Enable/disable continuous transmission
- Set frequency of printouts for continuous transmission

7.1.1 Port

- Enter **<P5.1.PC / 5.1.1.Prt>** submenu.
- Press  key, port options are displayed successively, where: **nonE** – none, **rS1** – RS232.
- Set respective value and press  key to confirm, next go to the home screen.



7.1.2 Continuous transmission

- Enter **<P5.1.PC / 5.1.2.Cnt>** submenu.
- Press  key, transmission options are displayed successively, where: **nonE** – Continuous transmission disabled, **CntA** – Continuous transmission in basic unit, **Cntb** – Continuous transmission in current/temporary unit.
- Set respective value and press  key to confirm, next go to the home screen.

7.1.3 Printout interval for continuous transmission

Parameter to set frequency of printout for continuous transmission. Printout interval is set in seconds, with 0.1 [s] accuracy within 0.1 [s] – 3600 [s] range.

1. Enter **<P5.1.PC / 5.1.3.Int>** submenu.

2. Enter transmission rate, to do this press  to select digit to be edited and  to set digit value (0 - 9).

3. Set respective value and press  key to confirm, next go to the home screen.

7.1.4 Printer

<5.2.Prtr> submenu allows to:

- Select port to which the printer is connected

7.1.5 Port

1. Enter **<P5.2.Prtr / 5.2.1.Prt>** submenu.

2. Press  key, options are displayed successively, where: **nonE** – No port selected, **rS1** – RS232.

3. Set respective value and press  key to confirm, next go to the home screen.

7.2 Additional display

<5.3.AdSP> submenu allows to:

- Select port to which the additional display is connected

7.2.1 Port

1. Enter **<P5.3.AdSP / 5.3.1.Prt>** submenu.

2. Press  key, options are displayed successively, where: **nonE** – No port selected, **rS1** – RS232 (1).

3. Set respective value and press  key to confirm, next go to the home screen.

8. Printouts

8.1 Calibration report

<P6.1.CrEP> is a group of parameters allowing to declare variables that are to be printed on the calibration report printout. Each variable allows for accessibility attribute: **YES** – print, **no** – do not print. Calibration report is automatically generated at the end of each calibration process.

Table 6. Calibration report variable list

Submenu	Name	Description
6.1.1.	CtP	Calibration type
6.1.2.	dAt	Calibration date
6.1.3.	tin	Calibration time
6.1.4.	ldb	Scale serial number
6.1.5.	CdF	Difference between mass of a calibration weight measured during the last calibration and mass of the currently measured calibration weight
6.1.6.	dSh	Dashed line separating printout data and signature fields
6.1.7.	SiG	An area for the signature of an operator carrying out the calibration

Figure 10. Calibration report example

```

-----Calibration Report-----
Calibration type           External
Date                       2016.10.15
Time                       12:39:23
Balance ID                 123456
Difference                  -0.02g
-----
Signature
.....

```

8.2 GLP printout

<P6.2.GLP> is a group of parameters allowing to declare variables that are to be printed on a weighing printout. Each variable allows for accessibility attribute: **YES** – print, **no** – do not print.

Table 7. GLP weighing printout variable list

Submenu	Name	Description
6.2.1.	dAt	Weighing date
6.2.2.	tin	Weighing time
6.2.3.	n	Net weight value of performed weighing in a basic measuring unit
6.2.4.	t	Tare weight value in a current unit
6.2.5.	b	Gross weight value in a current unit
6.2.6.	CrS	Current weighing result (net weight) in a current unit
6.2.7.	CrP	The last adjustment report generated in accordance with settings declared for the adjustment report printout

Figure 11. GLP printout example

Date	2016.10.15
Time	12:04:17
Net	49.98g
Tare	17.20g
Gross	67.18g

9. Miscellaneous parameters

<P7.Othr> is a group of parameters enabling to customize scale operation.

9.1 Backlight

Parameter allowing to change display brightness, the brightness can be changed within **0%** - **100%** range.

1. Enter <P7.Othr / 7.1.bLbt> submenu.



2. Press  key, options are displayed successively, where: **nonE** – Backlight off, **10** – Display brightness low limit value in [%], and **100** – Display brightness high limit value in [%] .



3. Set respective value and press  key to confirm, next go to the home screen.

9.2 'Beep' sound

Parameter allowing to enable/disable sound signal informing the operator about pressing panel key(s).

1. Enter <P7.Othr / 7.2.bEEP> submenu.



2. Press  key, options are displayed successively, where: **no** – sound signal disabled, **YES** – sound signal enabled.



3. Set respective value and press  key to confirm, next go to the home screen.

9.3 Automatic shutdown

Parameter allowing to set time interval, in [min], after which the weighing device shuts down automatically. If the indication is stable during the declared time interval, the device is shut down. Shutdown function is inactive, and the device cannot be turned off if any process is started or if you operate the menu.

1. Enter <P7.Othr / 7.3.t1> submenu.



2. Press  key, options are displayed successively, where: **nonE** – Function disabled, **1, 2, 3, 5, 10**.



3. Set respective value and press  key to confirm, next go to the home screen.

9.4 Date and time

Parameter allowing to set current date and time and to specify date and time format.

Enter <P7.Othr> submenu and change the settings as desired. Refer to the below table:

Table 8. GLP date and time printout variable list

Submenu	Description
<7.4.SdAt>	Enter this parameter to set current date, where the date format is YYYY.MM.DD*
<7.5.Stnn>	Enter this parameter to set current time, where the time format is 24H**
<7.6.FdAt>	Enter this parameter to set date format. Available values: 1 - DD.MM.YYYY, 2 - MM.DD.YYYY, 3 - YYYY.MM.DD* (set by default), 4 - YYYY.DD.MM
<7.7.Ftin>	Enter this parameter to set time format. Values: 24H** (set by default), 12H**

* Date format: Y – year, M – month, D – day.

** Time format: 12H – 12-hour format, 24H – 24-hour format.

9.5 Default user settings

Parameter allowing to restore default operator settings.

1. Enter <P7.Othr / 7.8.dFL> submenu, text <Cont?> is displayed (Continue?).



2. Press  key to confirm. The process of restoring default settings starts, this is signaled with display of 'dash', <- >.
3. Upon process completion, <7.8.dFLu> submenu is displayed. Return to the home screen.

10. Scale Data

Scale Data menu, <P8.InFo>, provides information on the weighing device and its program. The parameters serve informative purposes:

Table 9. Scale Data



Submenu	Description
<8.1.ldb>	Serial number of the scale
<8.2.PurS>	Program version
<8.4.PStP>	Settings printout. Enter the parameter to send scale settings to printer port (all parameters)

11. Working modes – General information

The scale features the following working modes:

- Weighing
- Parts Counting
- +/- control
- Percent Weighing %
- Peak Hold
- Totalizing
- Animal Weighing

11.1 Running working mode

1. Go to the home screen, press  key, name of the first available working mode is displayed.
2. Press  key, names of available working modes are displayed successively one by one.
3. Enter selected working mode, by pressing  key to confirm.

Note: The weighing device program has been designed to make the scale run, upon restart, with the latest operated working mode on.

11.2 Working mode local settings



Each working mode features specific (local) functions which enable customize scale operation. To go to local settings of each working mode, enter **<P3.Func>** submenu. Some special functions are available for all working modes, refer to the table below:

Table 10. Working mode settings

	Accessibility	Save mode	Time interval	Lo threshold
Weighing	3.1.1.Acc	3.1.2.Snn	3.1.3.Int	3.1.4.Lo
Parts Counting	3.2.1.Acc	3.2.3.Snn	3.2.4.Int	3.2.5.Lo
+/- control	3.3.1.Acc	3.3.2.Snn	3.3.3.Int	3.3.4.Lo
Percent Weighing %	3.4.1.Acc	3.4.3.Snn	3.4.4.Int	3.4.5.Lo
Peak Hold	3.5.1.Acc	-	-	3.5.2.Lo
Totalizing	3.6.1.Acc	3.6.2.Snn	3.6.3.Int	3.6.4.Lo
Animal Weighing	3.7.1.Acc	-	-	3.7.3.Lo

11.2.1 Working mode accessibility

To enable/disable given working mode, press  key.

1. Enter **<P3.Func>** menu and select a given working mode.
2. Go to **<Acc>** function.
3. Press  key, parameter values are displayed successively one by one, where: **YES** – working mode enabled, **no** – working mode disabled.
4. Press  key to confirm, next return to home screen.

11.2.2 Save mode

Parameter allowing to set mode of sending data from the weighing device to a peripheral device.





1. Enter **<P3.Func>** menu and select a given working mode.
2. Go to **<Snn>** function
3. Press  key, parameter values are displayed successively one by one, where:

Table 11. Save mode options

Option	Description
StAb	Manual printout of stable weighing result. Upon pressing  key at the moment when the result is unstable (no  pictogram displayed), the program first waits for the stability condition to be met, only then the printout is carried out
nStAb	Manual printout of each weighing result. In case of unstable indication, <?> sign is displayed in front of the 'mass frame'
rEPL	Automatic printout of the first stable weighing result above <Lo> threshold (to set <Lo> threshold go to <Lo> parameter)
rEPLi	Automatic printout with time interval set in [min] (to set the interval go to <Int> parameter)

4. Press  key to confirm, next return to home screen.

11.2.3 Automatic printout interval

Parameter enabling to set frequency of an automatic printout. Printout interval is set in minutes with 1 [min] accuracy within 1 [min] – 1440 [min] range.

1. Enter <P3.Func> menu and select a given working mode.
2. Enter <Int> function, window for enter **time interval** value is displayed.

3. Press  key to confirm, next return to home screen.

11.2.4 Lo threshold

<Lo> parameter allows to configure the function of automatic operation. The next measurement is saved only when mass indication gets below the set net value of **Lo threshold** parameter.

1. Enter <P3.Func> menu and select a given working mode.
2. Enter <Lo> function, window for enter **Lo threshold** value is displayed.

3. Enter respective value and press  key to confirm, next return to home screen.

12. Working mode – Weighing

<UUGG> is a standard working mode to carry out the weighing operation along with record of the result to the database.

12.1 Local settings

To go to local settings, enter <3.1.UUGG> submenu.

Table 12. Weighing – Local settings

Submenu	Setting
3.1.1.Acc	Working mode accessibility
3.1.2.Snn	Save mode
3.1.3.Int	Time interval
3.1.4.Lo	Lo threshold

13. Working mode – Parts Counting

Parts Counting is a working mode enabling to determine quantity of small pieces of the same mass, which determination is done on the basis of mass of sample piece (single part), and where the sample piece mass (single part mass) is determined using the weighing device.

13.1 Local settings

To go to local settings, enter <3.2.PcS> submenu.

Table 13. Parts Counting – Local settings

Submenu	Setting
3.2.1.Acc	Working mode accessibility
3.2.2.UUt	Operation mode
3.2.3.Snn	Save mode
3.2.4.Int	Time interval
3.2.5.Lo	Lo threshold

13.1.1 Working mode selection

Parameter allowing to select method of determination of sample piece mass.

1. Enter <3.2.PcS / 3.2.2.UUt> submenu.
2. Go to <Acc> function.



3. Press  key, parameter values are displayed successively one by one, where: **S_S** – Select to set sample mass by determining mass of a single part, **Suu** – Select to set sample mass by entering mass of a single part.



4. Enter respective value and press  key to confirm, then continue weighing.

13.2 Setting reference sample mass by entering mass of a single part

1. Enter <3.2.PcS / 3.2.2.UUt> submenu, set <Suu> value.
2. Enter <PcS> working mode (Parts Counting), first, text <Set_Ut> is displayed for 1s, next you see a window for entering mass value of a single part.



3. Enter respective value and press  key to confirm, the home screen is displayed automatically along with the quantity of parts loaded onto the weighing pan (pcs).



Note: If the value of entered single part mass is greater than max capacity value, then message <Err Hi> is displayed.

13.3 Setting reference sample mass by determining mass of a single part

1. Enter <3.2.PcS / 3.2.2.UUt> submenu, set <S_S> value.
2. Enter <PcS> working mode (Parts Counting), first, text <Set_Ut> is displayed for 1s, next you see a window for entering mass value of a single part.



3. Press  key to select one of the following options: **10** – 10 pieces, **20** – 20 pieces, **50** – 50 pieces, **100** – 100 pieces, **0000** – Custom reference sample quantity to enter required value.

4. Select respective option and press  key to confirm, first, text **<LoAd>** is displayed for 1 second, next you see a weighing window.
5. If the parts are to be weighed in a container, first put the container on a weighing pan and tare it.
6. Load the weighing pan with the declared amount of parts. When the indication is stable ( pictogram is displayed), press  key to confirm the mass.
7. Single part mass is calculated automatically, the quantity of parts (pcs) is displayed.

Note: Total weight value of all parts loaded onto the weighing pan cannot be greater than the max capacity value.

Note: Single part mass value must be equal or greater than 0.1 of the reading unit. Unless this condition is met, the weighing device displays a message **<ErrLo>**.

Note: In the course of parts quantity determination it is necessary to wait for a stable measurement  before confirming the declared quantity value.

14. Working mode - +/- control

+/- control is working mode enabling to enter checkweighing threshold values (**Min**, **Max**).



14.1 Local settings

To go to local settings, enter **<3.3.HiLo>** submenu.

Table 14. +/- control – Local settings

Submenu	Setting
3.3.1.Acc	Working mode accessibility
3.3.2.Snn	Save mode
3.3.3.Int	Time interval
3.3.4.Lo	Lo threshold

14.2 Declaring checkweighing thresholds

1. Enter **<HiLo>** working mode (+/- control), first, text **<SEt Lo>** is displayed for 1 s, next you see a window for declaring low weighing threshold (Min).
2. Enter a respective value and press  key to confirm, first, text **<SEt Hi>** is displayed for 1 second, next you see a window for declaring high weighing threshold (Max).
3. Enter respective value and press  key for confirmation, working modes home screen is displayed along with the declared threshold value, where: **Min** – Load mass lower than low weighing thresholds, **Ok** – Load mass within weighing thresholds, **Max** – Load mass greater than high weighing threshold.

Note: If the entered low threshold value (Min) is greater than the high threshold value (Max), **<Err Lo>** error is displayed.

Note: If the entered high threshold value (Max) is greater than the maximum capacity value, <Err Hi> error is displayed.

15. Working mode – Percent Weighing

Percent Weighing is a working mode enabling to compare measured load mass with the reference sample mass. The result is expressed in [%]. Reference sample mass can be either determined by weighing or entered to weighing device memory by an operator.

15.1 Local settings

To go to local settings, enter <3.4.dEu> submenu.

Table 15. Percent Weighing – Local settings

Submenu	Setting
3.4.1.Acc	Working mode accessibility
3.4.2.UUt	Operation mode
3.4.3.Snn	Save mode
3.4.4.Int	Time interval
3.4.5.Lo	Lo threshold

15.1.1 Working mode selection

Parameter allowing to select method of determination of reference sample mass.

1. Enter <3.4.dEu / 3.4.2.UUt> submenu.



2. Press  key, parameter values are displayed successively one by one, where: **S_S** – Select to set sample mass by determining the mass value, **Suu** – Select to set sample mass by entering the mass value.



3. Enter respective value and press  key to confirm, then continue to home screen.

15.2 Reference mass determined by weighing

1. Enter <3.4.dEu / 3.4.2.UUt> submenu, set <S_S> value.
2. Enter <dEu> working mode (Percent Weighing), first, text <LoAd> is displayed for 1s, next you see weighing result window.
3. Load the weighing pan with the reference sample. When the indication is stable ()



pictogram is displayed) press  key to confirm the mass.

4. Mass of the weighed load is automatically set as reference sample mass; the home screen is displayed along with **100.000%** value.

15.3 Reference sample mass by determining mass of a single part

1. Enter <3.4.dEu / 3.4.2.UUt> submenu, set <Suu> value.
2. Enter <dEu> working mode (Percent Weighing)
3. First, text <Set_Ut> is displayed for 1s, next you see a window for declaring mass of the reference sample.



4. Enter respective value and press  key to confirm. The home screen is displayed automatically with **0.000%** value.

Note: If the value of entered reference sample mass is greater than the max capacity value, then message **<Err Hi>** is displayed.

16. Working mode – Peak Hold

Peak Hold is a working mode allowing to snap value of maximum force applied to the weighing pan during one weighing process.

16.1 Local settings

To go to local settings, enter **<3.5.toP>** submenu.

Table 16. Peak Hold – Local settings

Submenu	Setting
3.5.1.Acc	Working mode accessibility
3.5.2.Lo	Lo threshold

16.2 Peak Hold operation

1. Enter **<3.5.toP / 3.5.2.Lo>** submenu, set **<Lo>** parameter value (Lo threshold) after exceeding of which maximum force is to be registered.
2. Enter **<toP>** working mode (Peak Hold). From now on the scale registers and holds every single weighing which is above the **Lo threshold**, and which is higher than the result of the previous Peak Hold. Snapped Peak Hold value is signaled by **<Max>** pictogram at the top of the screen.
3. The start of the next process of Peak Hold measurement is possible only after removing the load from the weighing pan and pressing  key.
4. This causes returning to the home screen of **<toP>** mode. Pictogram **<Max>** is automatically deleted.

17. Totalizing

Totalizing is a working mode enabling to sum mass of all weighed ingredients, and to print (via scale-connected printer) the total mass value. The pictogram allows to sum up to 30 weighings (ingredients) maximum within one process.

17.1 Local settings

To go to local settings, enter **<3.6.Add>** submenu.

Table 17. Totalizing – Local settings

Submenu	Setting
3.6.1.Acc	Working mode accessibility
3.6.2.Snn	Save mode
3.6.3.Int	Time interval
3.6.4.Lo	Lo threshold

17.2 Totalizing operation







1. Enter **<Add>** working mode (Totalizing), blinking “▲” pictogram is displayed.
2. If the ingredients are to be weighed in a container, first put the container on a weighing pan and tare it.
3. Load the weighing pan with the ingredient no. 1. When the indications are stable (▲ pictogram is displayed), press  key to confirm the mass.
4. Unload the weighing pan, **ZERO** is displayed, “▲” marker starts blinking again.
5. Load the weighing pan with the ingredient no.2, wait for a stable weighing result and press  key.
6. Total mass value of ingredient no. 1 and 2 is displayed, now the “▲” pictogram is displayed continuously.
7. In order to finish the process, press  key, text **<Prnt?>** (Print?) is displayed.
8. Press  key, total mass value of all recorded weighings is printed on a scale-connected printer.

Figure 12. Totalizing printout example

(1)	13.500 g
(2)	14.400 g
(3)	9.700 g
(4)	100.500 g
(5)	4.000 g
(6)	8.200 g
(7)	20.800 g
(8)	5.800 g

Total:	176.900 g

9. In order to print the report once again press  key.
10. To exit “report printout mode” press  key. As a result, the home screen of **<Add>** working mode is displayed and all the data get zeroed automatically.

Note: If the display capacity is exceeded (i.e. there is not enough space for all the digits of the weighing result) **<Hi>** error is displayed. In such a case either remove the ingredient from a weighing pan and finish the totalizing process or place load of a lower weight value on the weighing pan.

18. Working mode – Animal Weighing

Animal Weighing is a working mode enabling to weigh products that disrupt efficient establishing of stability. It is mostly intended to measure weight of animals.

18.1 Local settings

To go to local settings, enter <3.7.AnLS> submenu.

Table 18. Animal Weighing – Local settings

Submenu	Setting
3.7.1.Acc	Working mode accessibility
3.7.2. Aut	Averaging time
3.7.3.Lo	Lo threshold

18.2 Animal Weighing operation

1. Enter <AnLS> working mode (Animal Weighing).
2. First, text <tinnE> is displayed for 1s, next you see a window for setting duration (in seconds) of animal weighing.



3. Press keypad key, parameter values are displayed successively one by one, where: 5[s], 10[s], 20[s], 30[s], 40[s], 50[s], 60[s].



4. Set the respective value, press keypad key to confirm, weighing result window with **A** letter is displayed.
5. Load the weighing pan with an animal.
6. On exceeding the set mass value of <Lo threshold> parameter, animal weighing starts, this is signaled with display of 'dash' <- >.
7. Upon process completion, mass value of an animal is snapped and displayed together with **OK** pictogram in the upper part of the display. The snapped mass value is sent to a scale-connected printer.
8. Press keypad key to restart animal weighing.
9. Press keypad key to reprint the snapped mass value.
10. Upon unloading of the weighing platform, the weighing result window with letter **A** is displayed. The scale can be loaded with an animal again.

19. Maintenance

In order to ensure safety in the course of cleaning, it is necessary to disconnect the device from the mains. With this condition met, uninstall the weighing pan and other detachable scale components.

Note: *Cleaning the weighing pan while still installed may cause damage of the measuring system.*

19.1 Cleaning ABS components

To clean dry surfaces and avoid smudging, use clean non-coloring cloths made of cellulose or cotton. You can use a solution of water and detergent (soap, dishwashing detergent, glass cleaner). Gently rub the cleaned surface and let it dry. Repeat cleaning process if needed.

In the case of hard to remove contamination, e.g. residues of adhesive, rubber, resin, polyurethane foam etc., you can use a special cleaning agent based on a mixture of aliphatic hydrocarbons that do not dissolve plastics. Before using the cleanser for all surfaces, we recommend carrying out tests. Do not use cleansers containing abrasive substances.

19.2 Cleaning stainless steel components

Avoid using cleansers containing any corrosive chemicals, e.g. bleach (including chlorine). Do not use cleansers containing abrasive substances. Always remove the dirt using microfiber cloth to avoid damage of protective coating.

In case of a daily maintenance:

- Remove the dirt using cloth dipped in warm water
- For best results, add a little bit of dishwashing detergent

19.3 Cleaning aluminum components

While cleaning aluminum components use products acid by nature, e.g. spirit vinegar, lemon. Do not use cleansers containing abrasive substances. Avoid using hard brush, this may cause scratches. It is recommended to use microfiber cloth. While polishing the surface use circular movements. Use clean, dry cloth to make the surface shine.

20. Mechanical design

20.1 Dimensions

Figure 13. Scale dimensions

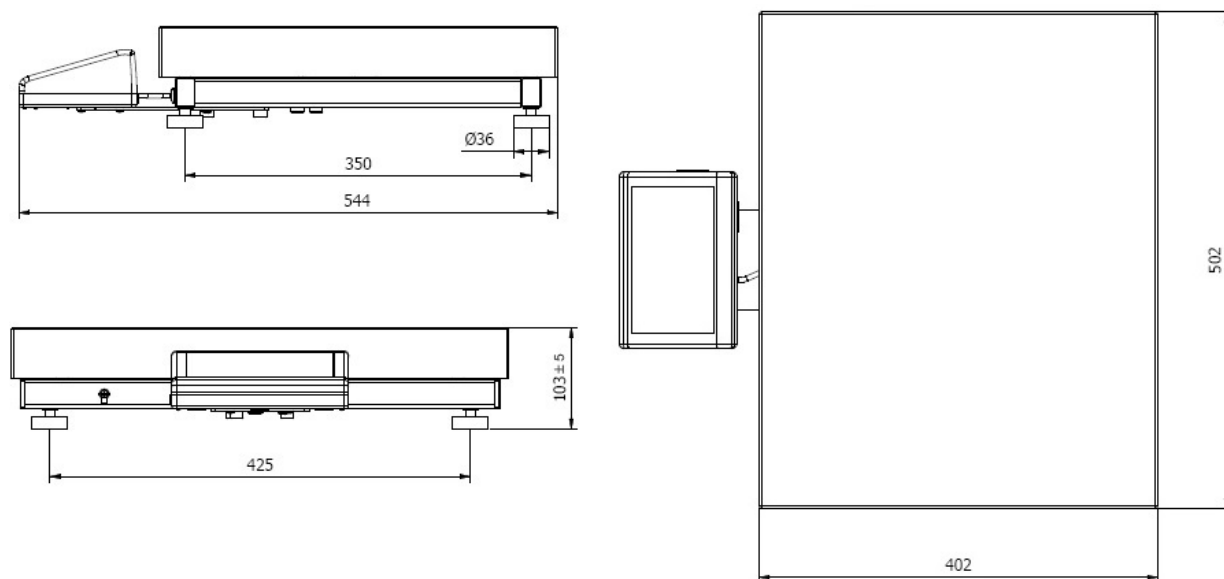

20.2 Connectors arrangement

Figure 14. Scale connectors

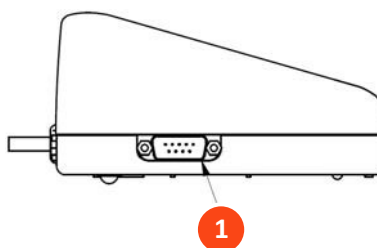

Connectors view

1. RS232 connector

Figure 15. RS-232 connector

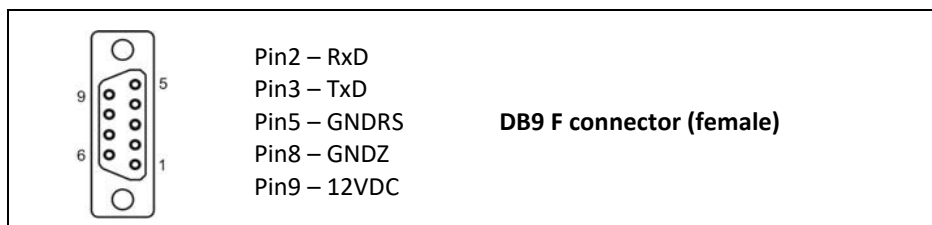

21. Troubleshooting

Table 19. Troubleshooting suggestions

Problem	Cause	Solution
The scale switches off automatically	<7.3.t1> parameter set to value enforcing scale shut-down after particular time interval	Go to 'Othr' menu, set <7.3.t1> parameter to 'nonE' value
During switching on, message 'LH' is displayed	Weighing pan loaded during the switching-on process	Unload the weighing pan. Zero indication is displayed

22. Error messages

Table 20. Error messages

Error	Cause
-Err 2-	Value beyond zero range
-Err 3-	Value beyond tare range
-Err 4-	Calibration weight or start mass out of range ($\pm 1\%$ for calibration weight, ± 10 for start mass)
-Err Lo-	Determined mass of single part in 'Parts Counting' mode too small Value of 'Min' threshold is greater than value of 'Max' threshold in '+/- control' mode
-Err Hi-	Entered value of single part greater than maximum capacity in 'Parts Counting' working mode Entered value of 'Max' threshold greater than maximum capacity in '+/- control' mode Entered reference mass greater than maximum capacity in 'Percent Weighing' mode
-Err 8-	Time of the following operations exceeded: taring, zeroing, start mass determining, calibration
-null-	Zero value from the converter
-FULL-	Weighing range exceeded
-LH-	Start mass error, indication out of range ($\pm 10\%$ of start mass)
-Hi-	Display range of total mass on scale display exceeded in 'Totalizing' mode

23. Index

Calibration.....	10, 13, 14, 18, 19, 32	Note	15, 16, 22, 24, 25, 26, 27, 28, 29
Connectors	31	Operating	10
Devices	10, 17	Parameters.....	10, 14, 18, 19, 20, 21
Error	25, 26, 28, 32	Precautions	7
Good weighing practices.....	12	Troubleshooting.....	32
Maintenance	30		